

2J520

2J520W

(DATASHEET)

Type
Frequencies

LTE Antenna
AMPS (824-894 MHz)
GSM (900 MHz)
DCS (1800 MHz)
PCS (1900 MHz)
3G (UMTS 2.1 GHz)
WIFI / BLUETOOTH (2.4 GHz)
4G/LTE (699-960/1710-2690 MHz)

Mounting
Revision

Glass Mount
00



P. Tipul

D. Noble

1. PRODUCT SELECTION

2J520 Black version
 2J520W White version

2. SPECIFICATION

2.1. Electrical Specifications

Frequencies	AMPS (824-894 MHz) GSM (900 MHz) DCS (1800 MHz) PCS (1900 MHz) 3G (UMTS 2.1 GHz) WIFI / BLUETOOTH (2.4 GHz) 4G/LTE (699-960/1710-2690 MHz)
Impedance	50 Ohms
Polarization	Linear
Gain	2.14dBi
VSWR	Full 4G/LTE <5:1 / Europe: <2:1
Power handling	25W
Operating temperature	-40°C to +85°C

2.2. Connection Specifications

Connector type: SMA male
 Cable: RG174U
 Cable length: 30 cm

For different cable and connector type ask our sales team.

2.3. Mechanical Specifications and Dimensions

Material: PVC
 Max. dimensions: 6.7mm x 117.4mm x 12.5mm (H x L x W)
 Weight: 13 g ‘weight with 250cm cable length and SMA connector’
 Colour: Black or White(for different colours please ask our sales team)

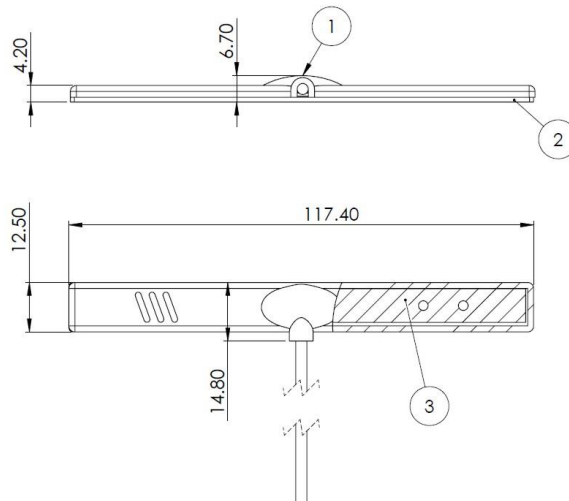

3. MEASUREMENT

3.1. S11

Log Mag (Quad Band)

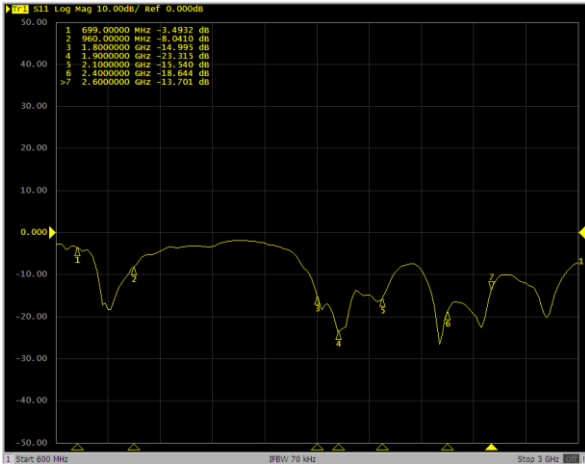

VSWR (Quad Band)

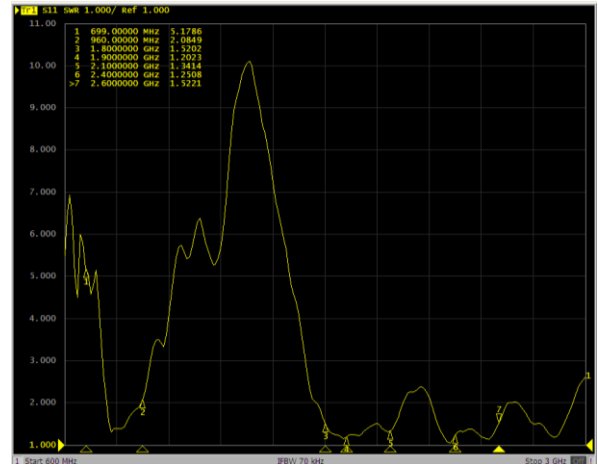

Tested with 30cm cable length and 6mm thin glass.

Tested with 30cm cable length and 6mm thin glass.

3.2. 3D Spherical

- Legend bar is showing antenna gain

Freq = 0.8500GHz Az= 45 EL= 45

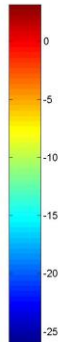
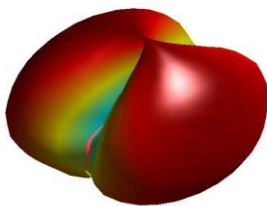

Freq = 0.9GHz Az= 45 EL= 45

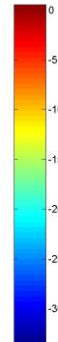
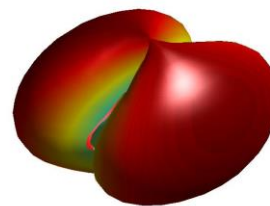

Freq = 1.8GHz Az= 45 EL= 45

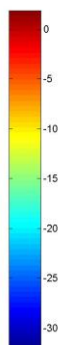
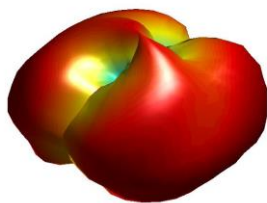

Freq = 1.9GHz Az= 45 EL= 45

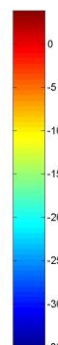
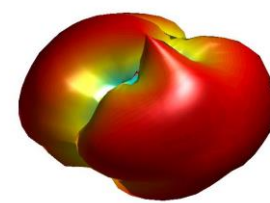

Freq = 2.1GHz Az= 45 EL= 45

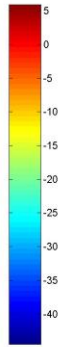
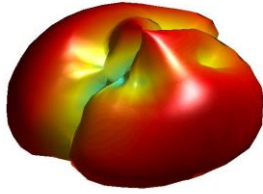

Freq = 2.41GHz Az= 45 EL= 45

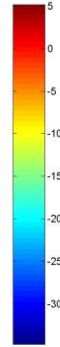
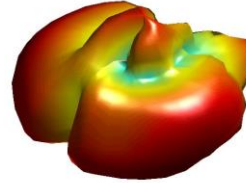

Freq = 2.6GHz Az= 45 EL= 45

